

## Bridge Rectifiers

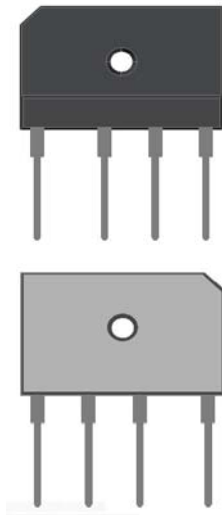

### Features

- Thin single in-line package
- High surge current capability
- Solder dip 275 °C max. 7 s, per JESD 22-B106

### Mechanical Data

- **Package:** PB  
Molding compound meets UL 94 V-0 flammability rating, RoHS-compliant, Halogen free
- **Terminals:** Tin plated leads, solderable per J-STD-002 and JESD22-B102
- **Polarity:** As marked on body

### ■Maximum Ratings (T<sub>a</sub>=25°C Unless otherwise specified)

PARAMETER	SYMBOL	UNIT	YG50DD160	
Device marking code			YG50DD160	
Maximum Repetitive Peak Reverse Voltage	VRRM	V	1600	
Maximum RMS Voltage	VRMS	V	1120	
Maximum DC blocking Voltage	VDC	V	1600	
Average rectified output current @60Hz sine wave, R-load	With heatsink T <sub>c</sub> =100°C	I <sub>o</sub>	A	50*2
	Without heatsink T <sub>a</sub> =25°C			15*2
Forward Surge Current (Non-repetitive) @60Hz Half-sine wave, 1 cycle, T <sub>j</sub> =25°C	I <sub>FSM</sub>	A	600	
Forward Surge Current (Non-repetitive) @1ms, square wave, 1 cycle, T <sub>j</sub> =25°C			1200	
Current squared time @1ms≤t≤8.3ms T <sub>j</sub> =25°C	I <sup>2</sup> t	A <sup>2</sup> s	1494	
Storage temperature	T <sub>stg</sub>	°C	-55 ~ +150	
Junction temperature	T <sub>j</sub>	°C	-55 ~ +150	
Dielectric strength @ Terminals to case, AC 1 minute	V <sub>dis</sub>	KV	2.5	
Mounting torque @Recommend torque: 5kg·cm	Tor	kg·cm	8	

### ■Electrical Characteristics (T<sub>a</sub>=25°C Unless otherwise specified)

PARAMETER	SYMBOL	UNIT	TEST CONDITIONS	YG50DD160
Maximum instantaneous forward voltage	V <sub>F</sub>	V	I <sub>FM</sub> =25A	1.05
Maximum DC reverse current at rated DC blocking voltage	I <sub>R</sub>	μA	T <sub>j</sub> =25°C	5
			T <sub>j</sub> =125°C	1000



# YG50DD160

## ■ Thermal Characteristics (T<sub>a</sub>=25°C Unless otherwise specified)

PARAMETER		SYMBOL	UNIT	YG50DD160
Thermal Resistance	Between junction and ambient, Without heatsink	R <sub>θJ-A</sub>	°C/W	18.0
	Between junction and lead, With heatsink	R <sub>θJ-L</sub>		5.0
	Between junction and case, With heatsink	R <sub>θJ-C</sub>		0.75

Note: Device mounted on 75mm x 45mm x 5.5mm Aluminum Plate Heatsink.

## ■ Ordering Information (Example)

PREFERRED P/N	PACKING CODE	UNIT WEIGHT(g)	MINIMUM PACKAGE(pcs)	INNER BOX QUANTITY(pcs)	OUTER CARTON QUANTITY(pcs)	DELIVERY MODE
YG50DD160	B1	Approximate 7.5	15	750	1500	TUBE

## ■ Characteristics (Typical)

FIG1: I<sub>o</sub>-T<sub>c</sub> Curve

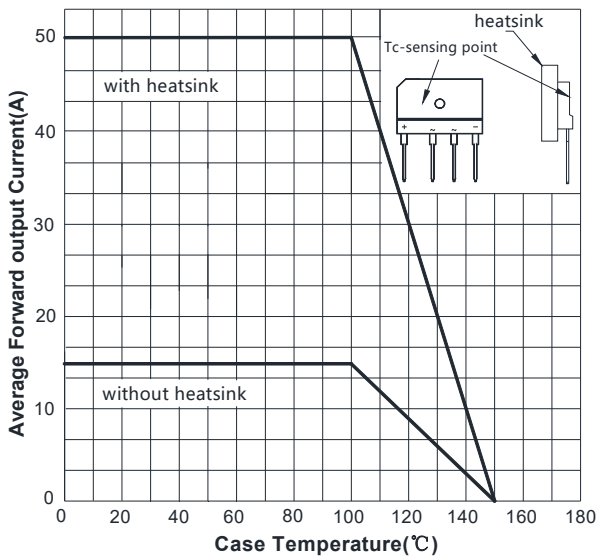

FIG2: Surge Forward Current Capability

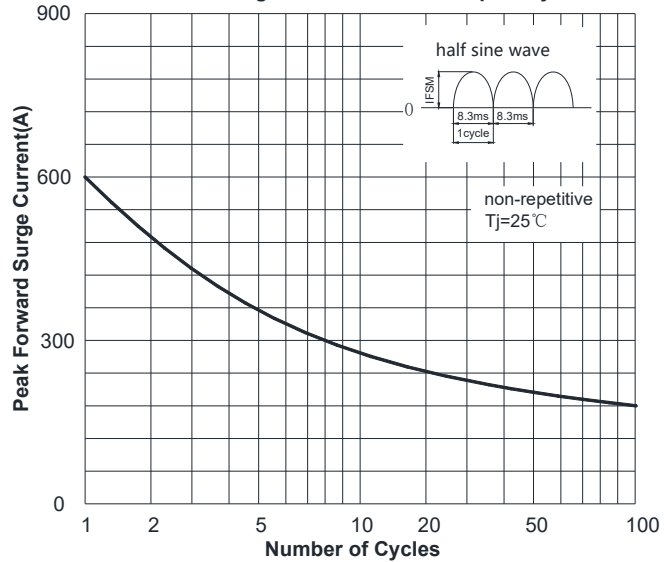

FIG3: Typical Forward Voltage

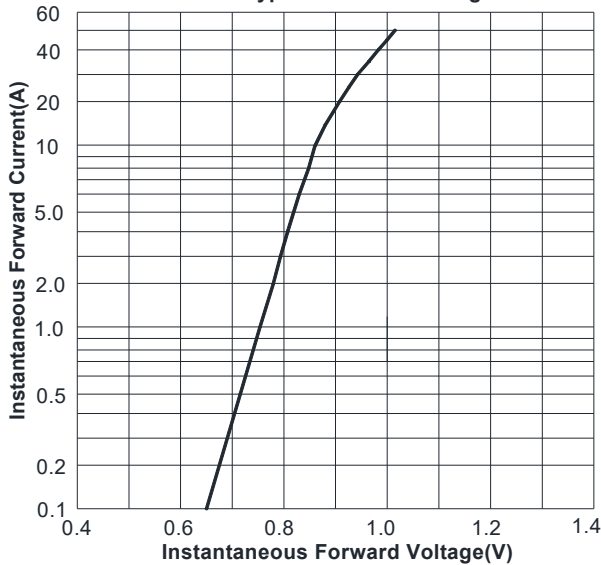
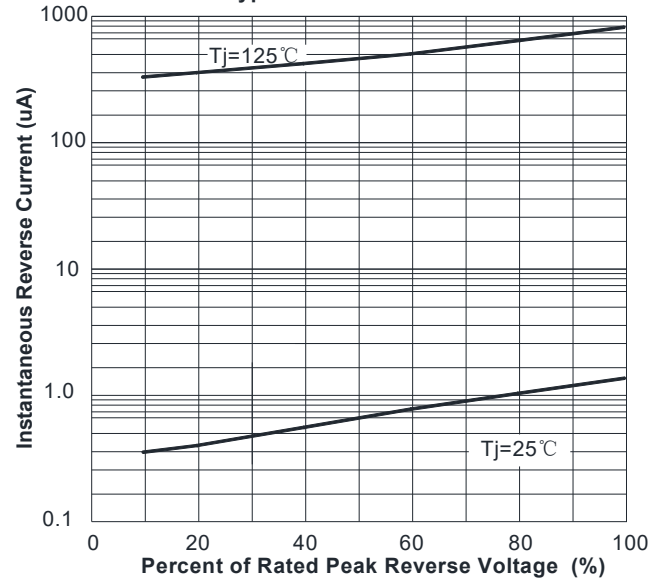

FIG4: Typical Reverse Characteristics





# YG50DD160

## ■ Electrical circuit diagram and structural diagram

Electrical circuit diagram

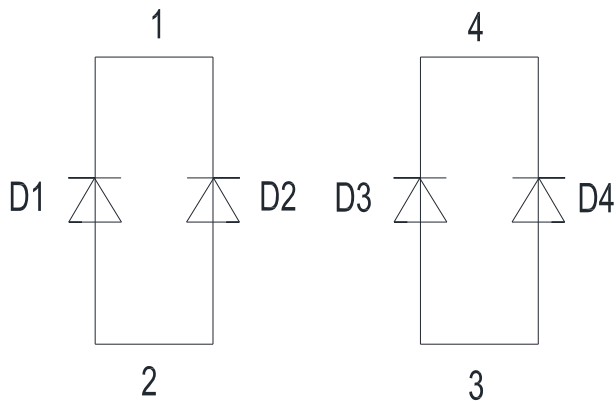

Structural diagram

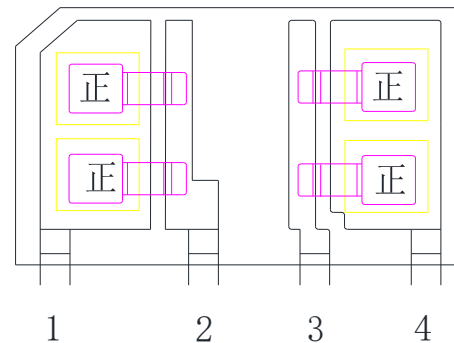

## ■ Outline Dimensions

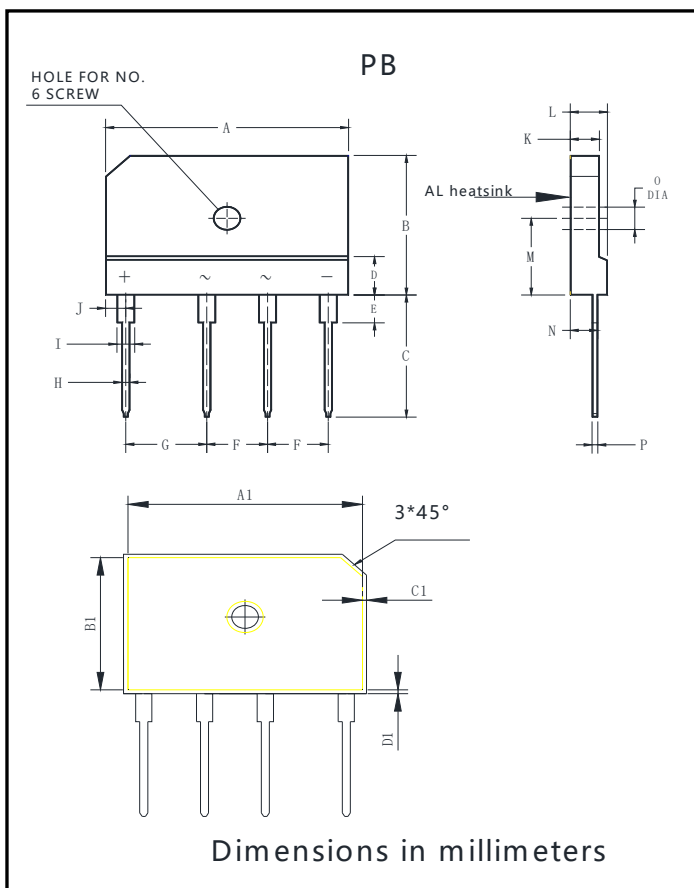

PB		
Dim	Min	Max
A	29.7	30.3
B	19.7	20.3
C	17.0	18.0
D	4.8	5.8
E	3.8	4.2
F	7.3	7.7
G	9.8	10.2
H	0.9	1.1
I	2.0	2.4
J	2.3	2.7
K	3.4	3.8
L	4.4	4.8
M	10.8	11.2
N	3.1	3.7
O	3.1	3.4
P	0.6	0.8
A1	28.75	29.15
B1	18.75	19.15
C1	0.3	0.7
D1	0.3	0.7



## Disclaimer

The information presented in this document is for reference only. Yangzhou Yangjie Electronic Technology Co., Ltd. reserves the right to make changes without notice for the specification of the products displayed herein to improve reliability, function or design or otherwise.

The product listed herein is designed to be used with ordinary electronic equipment or devices, and not designed to be used with equipment or devices which require high level of reliability and the malfunction of which would directly endanger human life (such as medical instruments, transportation equipment, aerospace machinery, nuclear-reactor controllers, fuel controllers and other safety devices), Yangjie or anyone on its behalf, assumes no responsibility or liability for any damages resulting from such improper use of sale.

This publication supersedes & replaces all information previously supplied. For additional information, please visit our website [http:// www.21yangjie.com](http://www.21yangjie.com) , or consult your nearest Yangjie's sales office for further assistance.