

Silicon Carbide Schottky Diode

| | |
|---------------|-------|
| V_{RRM} | 1200V |
| I_F (135°C) | 51A |
| Q_C | 216nC |

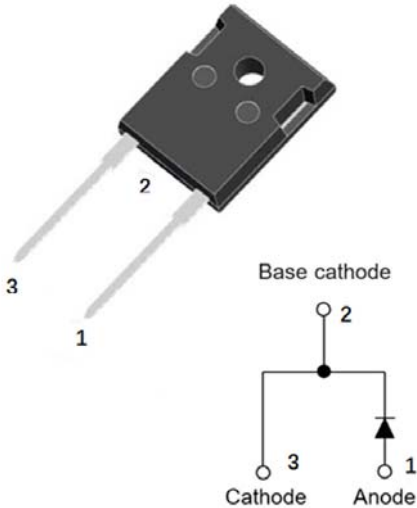

Features

- Positive temperature coefficient
- Temperature-independent switching
- Maximum working temperature at 175 °C
- Unipolar devices and zero reverse recovery current
- Zero forward recovery current
- Essentially no switching losses
- Reduction of heat sink requirements
- High-frequency operation
- Reduction of EMI

Typical Applications

Typical applications are in power factor correction(PFC), solar inverter, uninterruptible power supply, motor drives, photovoltaic inverter, electric car and charger.

Mechanical Data

- **Package:** TO-247AC
- **Terminals:** Tin plated leads
- **Polarity:** As marked

■Maximum Ratings ($T_c=25^\circ\text{C}$ Unless otherwise specified)

| PARAMETER | SYMBOL | UNIT | VALUE |
|--|----------------|----------------------|-----------------|
| Device marking code | | | D112040NQG2 |
| Reverse voltage (repetitive peak) @ $T_j=25^\circ\text{C}$ | V_{RRM} | V | 1200 |
| Reverse voltage (Surge Peak) @ $T_j=25^\circ\text{C}$ | V_{RSM} | V | 1200 |
| Reverse voltage (DC) @ $T_j=25^\circ\text{C}$ | V_{DC} | V | 1200 |
| Continuous forward current @ $T_c=25^\circ\text{C}$ $T_c=135^\circ\text{C}$ $T_c=144^\circ\text{C}$ | I_F | A | 105 51 40 |
| Non-repetitive peak forward surge current @ $T_c=25^\circ\text{C}$, $t_p=10\text{ms}$, Half Sine Wave | I_{FSM} | A | 280 |
| Power Dissipation@ $T_c=25^\circ\text{C}$ $T_c=110^\circ\text{C}$ | P_{TOT} | W | 440 191 |
| i^2t Value@ $T_c=25^\circ\text{C}$, $t_p=10\text{ms}$ | $\int i^2 dt$ | A^2S | 392 |
| Operating junction and Storage temperature range | T_j, T_{stg} | $^\circ\text{C}$ | -55 to +175 |



YJD112040NQG2

■Electrical Characteristics

| PARAMETER | SYMBOL | UNIT | TEST CONDITIONS | Typ. | Max. |
|---------------------------|--------|---------|--|------|------|
| Forward voltage drop | V_F | V | $I_F=40A, T_j=25^\circ C$ | 1.41 | 1.58 |
| | | | $I_F=40A, T_j=175^\circ C$ | 2.02 | |
| Reverse leakage current | I_R | μA | $V_R=1200V, T_j=25^\circ C$ | 3.1 | 38 |
| | | | $V_R=1200V, T_j=175^\circ C$ | 19 | |
| Total capacitive charge | Q_C | nC | $V_R=800V, T_j=25^\circ C, Q_C=\int_0^{V_R} I_R C(V) dV$ | 216 | |
| Total capacitance | C | μF | $V_R=0V, f=1MHZ$ | 2900 | |
| | | | $V_R=400V, f=1MHZ$ | 204 | |
| | | | $V_R=800V, f=1MHZ$ | 156 | |
| Capacitance Stored Energy | E_C | μJ | $V_R=800V$ | 55 | |

■Thermal Characteristics ($T_a=25^\circ C$ Unless otherwise specified)

| PARAMETER | SYMBOL | UNIT | VALUE |
|--------------------|------------------|--------------|-------|
| Thermal resistance | $R_{\theta J-C}$ | $^\circ C/W$ | 0.34 |

■Characteristics (Typical)

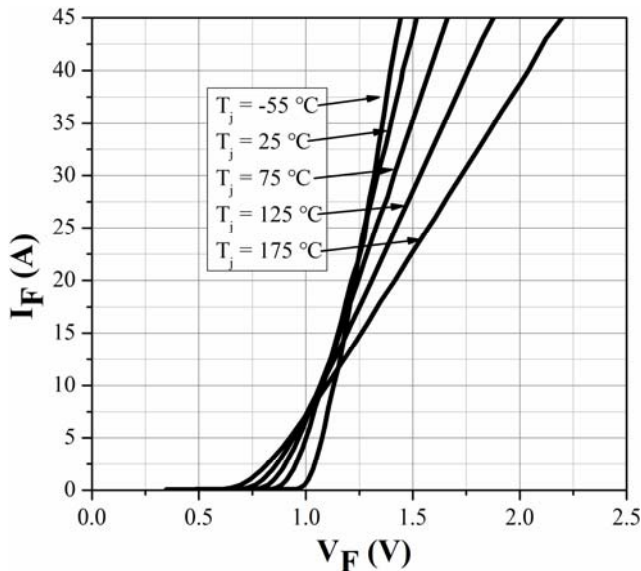

Figure 1. Forward Characteristics

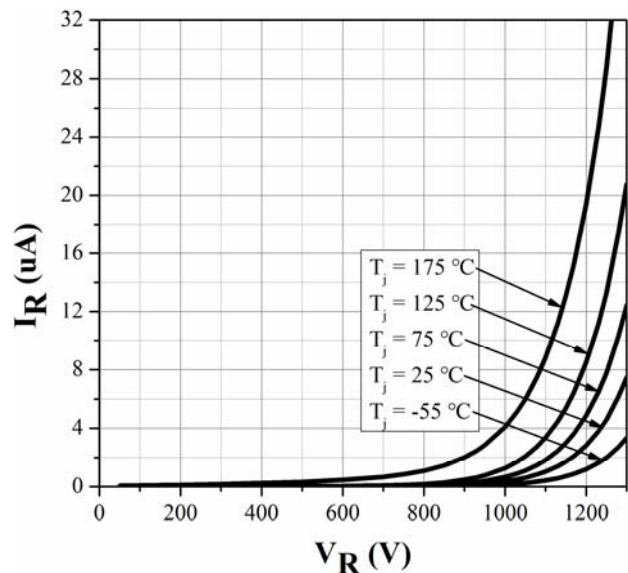

Figure2. Reverse Characteristic



YJD112040NQG2

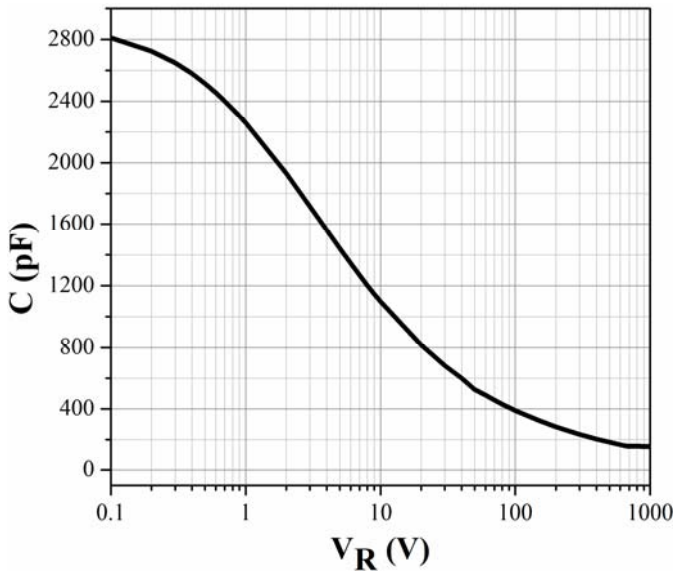

Figure 3. Capacitance vs. Reverse Voltage

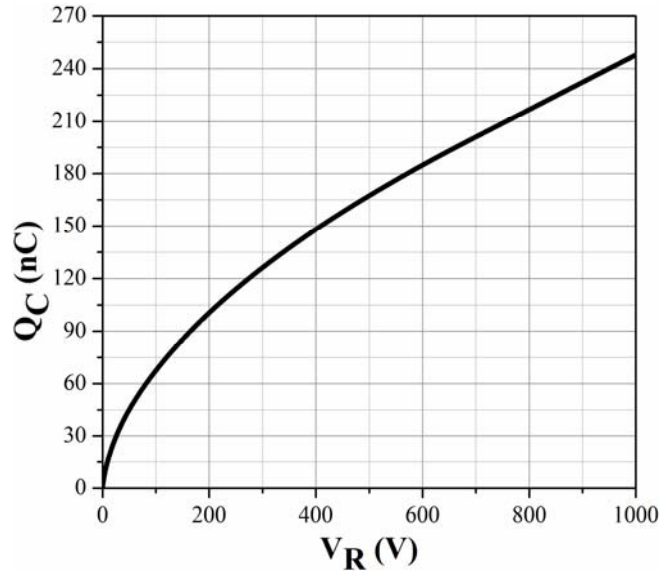

Figure 4. Total Capacitance Charge vs. Reverse Voltage

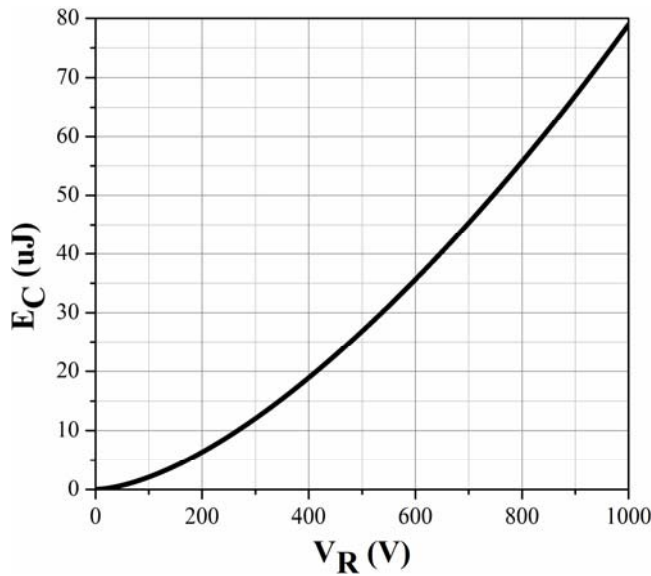

Figure 5. Capacitance Stored Energy

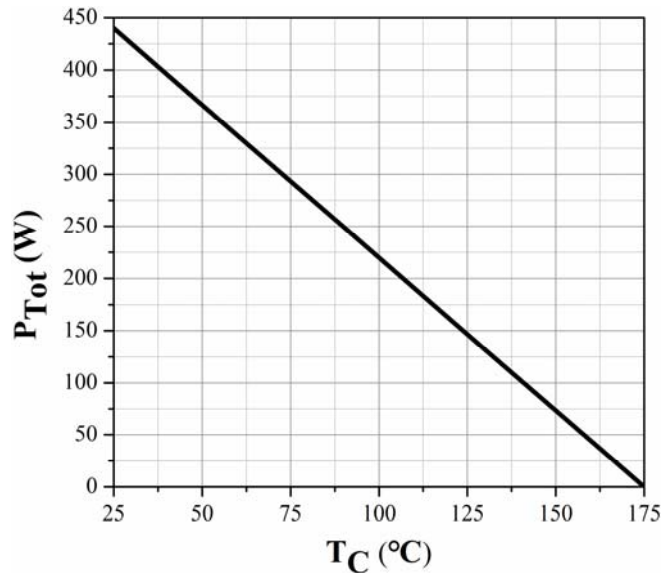

Figure 6. Power Derating

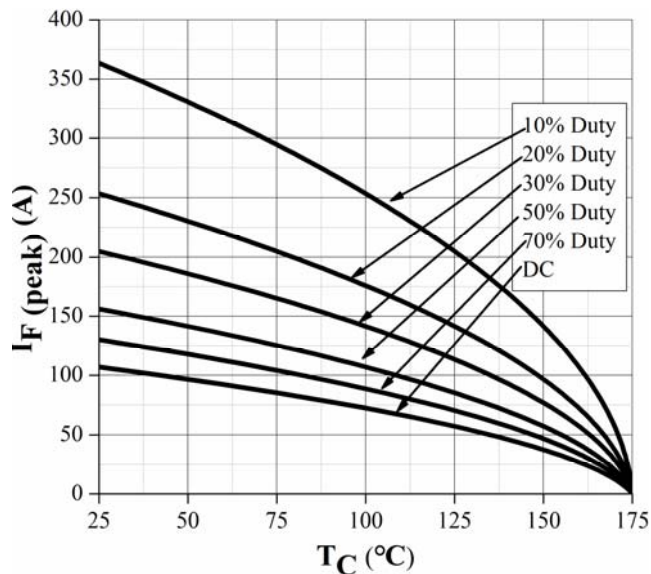

Figure 7. Current Derating

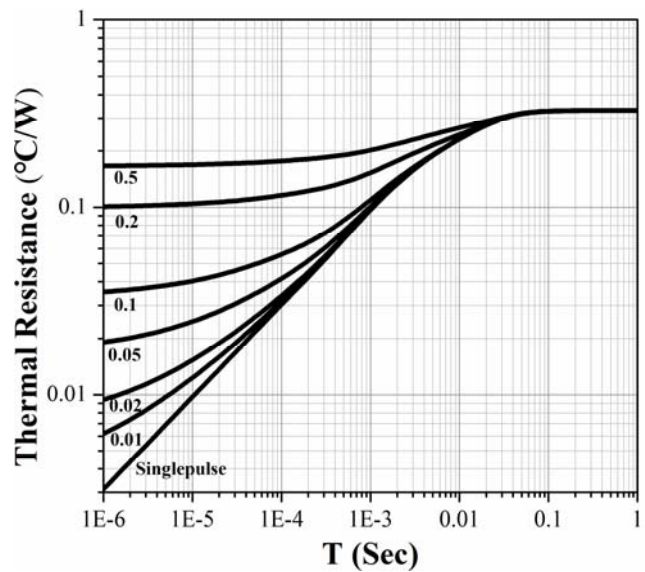

Figure 8. Transient Thermal Impedance



YJD112040NQG2

■Outline Dimensions

TO-247AC

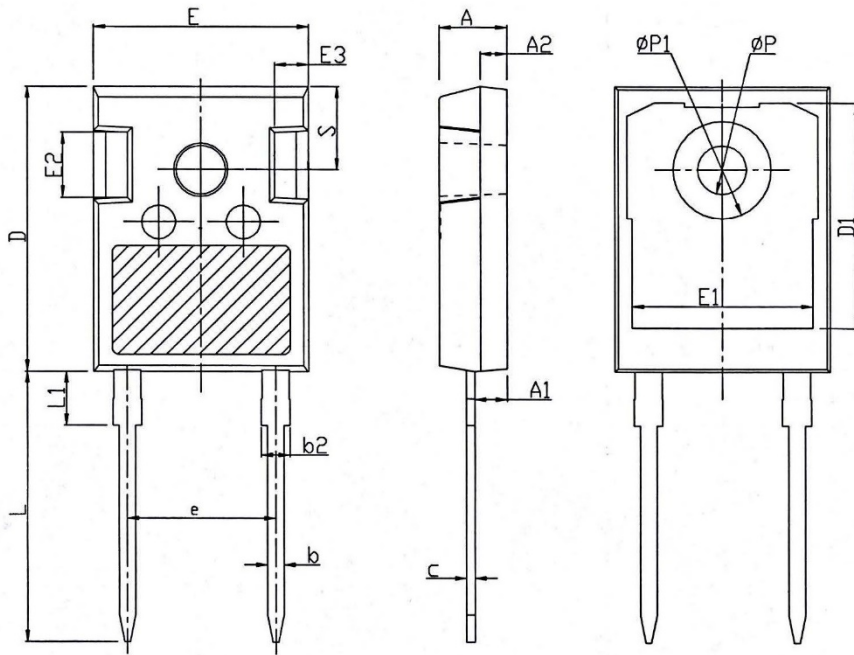

| TO-247AC | | |
|-----------|----------|-------|
| Dim | Min | Max |
| A | 4.80 | 5.20 |
| A1 | 2.21 | 2.61 |
| A2 | 1.85 | 2.15 |
| b | 1.11 | 1.36 |
| b2 | 1.91 | 2.21 |
| c | 0.51 | 0.75 |
| D | 20.70 | 21.30 |
| D1 | 16.25 | 16.85 |
| E | 15.50 | 16.10 |
| E1 | 13.00 | 13.60 |
| E2 | 4.80 | 5.20 |
| E3 | 2.30 | 2.70 |
| e | 10.88BSC | |
| L | 19.62 | 20.22 |
| L1 | - | 4.30 |
| ϕP | 3.40 | 3.80 |
| $\phi P1$ | - | 7.30 |
| S | 6.15BSC | |



Disclaimer

The information presented in this document is for reference only. Yangzhou Yangjie Electronic Technology Co., Ltd. reserves the right to make changes without notice for the specification of the products displayed herein to improve reliability, function or design or otherwise.

The product listed herein is designed to be used with ordinary electronic equipment or devices, and not designed to be used with equipment or devices which require high level of reliability and the malfunction of which would directly endanger human life (such as medical instruments, transportation equipment, aerospace machinery, nuclear-reactor controllers, fuel controllers and other safety devices), Yangjie or anyone on its behalf, assumes no responsibility or liability for any damages resulting from such improper use of sale.

This publication supersedes & replaces all information previously supplied. For additional information, please visit our website [http:// www.21yangjie.com](http://www.21yangjie.com) , or consult your nearest Yangjie's sales office for further assistance.