

## Silicon Carbide Power MOSFET (N-Channel Enhancement)

$V_{DS}$	1200V
$I_D$ (25°C)	66A
$R_{DS(on)}$	33mΩ

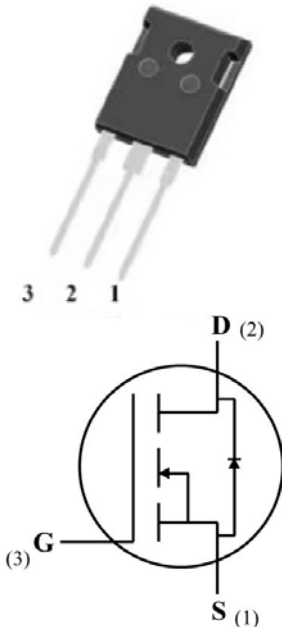

### Features

- High speed switching
- Essentially no switching losses
- Reduction of heat sink requirements
- Maximum working temperature at 175 °C
- High blocking voltage
- Fast Intrinsic diode with low recovery current
- High-frequency operation
- Halogen free, RoHS compliant
- AEC-Q101 qualified

### Typical Applications

Typical applications are in power factor correction(PFC), solar inverter, uninterruptible power supply, motor drives, photovoltaic inverter, electric car and charger.

### Mechanical Data

- **Package:** TO-247AB
- **Terminals:** Tin plated leads
- **Polarity:** As marked

### ■Maximum Ratings (T<sub>c</sub>=25°C Unless otherwise specified)

PARAMETER	SYMBOL	UNIT	VALUE	TEST CONDITIONS	NOTE
Device marking code			D212040NCTG2Q		
Drain source voltage @ T <sub>j</sub> =25°C	$V_{DS,max}$	V	1200	$V_{GS}=0V, I_D=100\mu A$	
Gate source voltage @ T <sub>j</sub> =25°C	$V_{GS,max}$	V	-8/+19	Absolute maximum values	
Gate source voltage @ T <sub>j</sub> =25°C	$V_{GS,op}$	V	-4/+15	Recommended operational values	Note1、2
Continuous drain current @ T <sub>c</sub> =25°C	$I_D$	A	66	$V_{GS}=15V, T_c=25^\circ C$	Fig.18
Continuous drain current @ T <sub>c</sub> =100°C			48	$V_{GS}=15V, T_c=100^\circ C$	
Pulsed drain current	$I_{D(pulsed)}$	A	120	Pulse width t <sub>p</sub> limited by T <sub>j,max</sub>	Fig.23
Power Dissipation	$P_{TOT}$	W	333	T <sub>c</sub> =25°C, T <sub>j</sub> = 175°C	Fig.17
Power Dissipation			144	T <sub>c</sub> =110°C, T <sub>j</sub> = 175°C	
Operating junction and Storage temperature range	T <sub>j</sub> , T <sub>stg</sub>	°C	-55 to +175		
Soldering temperature	T <sub>L</sub>	°C	260	1.6mm (0.063") from case for 10s	
Mounting torque	T <sub>M</sub>	Nm	0.6	M3 screw Maximum of mounting process: 3	



# YJD212040NCTG2Q

## ■Static Electrical Characteristics (Tc=25°C unless otherwise specified)

PARAMETER	SYMBOL	UNIT	Min.	Typ.	Max.	Test Conditions	Note
Gate threshold voltage	V <sub>GS(th)</sub>	V	2.0	2.5	3.5	V <sub>DS</sub> =V <sub>GS</sub> , I <sub>D</sub> = 11.5mA	Fig.4, 11
				2.0		V <sub>DS</sub> =V <sub>GS</sub> , I <sub>D</sub> = 10mA, T <sub>j</sub> =175°C	
Drain source breakdown voltage	V <sub>(BR)DSS</sub>	V	1200			V <sub>GS</sub> =0, I <sub>D</sub> =100uA	
Zero gate voltage drain current	I <sub>DSS</sub>	uA		1	50	V <sub>DS</sub> =1200V, V <sub>GS</sub> = 0V	Fig.16
Gate source leakage current	I <sub>GSS</sub>	nA		10	100	V <sub>GS</sub> = 15V, V <sub>DS</sub> =0V	
Current drain source on-state resistance	R <sub>DS ON</sub>	mΩ		33	44	V <sub>GS</sub> =15V, I <sub>D</sub> =40A	Fig.5, 6, 7
				63		V <sub>GS</sub> =15V, I <sub>D</sub> =40A, T <sub>j</sub> =175°C	
Internal gate resistance	R <sub>g</sub>	Ω		1.8		f=1MHz	
Diode forward voltage	V <sub>SD</sub>	V		5.0		V <sub>GS</sub> =-4V, I <sub>SD</sub> =20A	Fig.8
				3.3		V <sub>GS</sub> =0V, I <sub>SD</sub> =20A T <sub>j</sub> =175°C	Fig.9
Transconductance	g <sub>f</sub>	S		26		V <sub>DS</sub> =20V, I <sub>D</sub> =40A	Fig.4
				22		V <sub>DS</sub> =20V, I <sub>D</sub> =40A, T <sub>j</sub> =175°C	

## ■Dynamic Electrical Characteristics (Tc=25°C unless otherwise specified)

PARAMETER	SYMBOL	UNIT	Min.	Typ.	Max.	Test Conditions	Note
Input capacitance	C <sub>iss</sub>	pF		3456		V <sub>DS</sub> =1000V, V <sub>GS</sub> =0V, T <sub>j</sub> =25°C, f=100 kHz, V <sub>AC</sub> = 25mV	Fig.13, 14
Output capacitance	C <sub>oss</sub>			127			
Reverse capacitance	C <sub>rss</sub>			7.2			
Coss stored energy	E <sub>oss</sub>	uJ		69			Fig.15
Gate source charge	Q <sub>gs</sub>	nC		39		V <sub>DS</sub> =800V, V <sub>GS</sub> =-4/15V, I <sub>D</sub> =40A	Fig.12
Gate drain charge	Q <sub>gd</sub>			44			
Gate charge	Q <sub>g</sub>			116			

## ■Switching Characteristics (Tc=25°C unless otherwise specified)

PARAMETER	SYMBOL	UNIT	Min.	Typ.	Max.	Test Conditions	Note
Turn on switching energy	E <sub>on</sub>	uJ		80		V <sub>DD</sub> =800V, V <sub>GS</sub> =-4/+15V, I <sub>D</sub> =40A, R <sub>g</sub> =2.5Ω, L=65uH	Fig.21, 22
Turn off switching energy	E <sub>off</sub>			500			
Turn on delay time	t <sub>d(on)</sub>	ns		23			
Rise time	t <sub>r</sub>			8			
Turn off delay time	t <sub>d(off)</sub>	ns		31		V <sub>DD</sub> =800V, V <sub>GS</sub> =-4/+15V, I <sub>D</sub> =40A, R <sub>g</sub> =2.5Ω, L=65uH	Fig.21, 22
Fall time	t <sub>f</sub>			20			



# YJD212040NCTG2Q

## ■Body diode characteristics (Tc=25°C unless otherwise specified)

PARAMETER	SYMBOL	UNIT	Min.	Typ.	Max.	Test Conditions	Note
Diode forward voltage	V <sub>SD</sub>	V		5.0		V <sub>GS</sub> =-4V, I <sub>SD</sub> =20A	Fig.8
				3.3		V <sub>GS</sub> =0V, I <sub>SD</sub> =20A, T <sub>J</sub> =175°C	Fig.9
Continuous diode forward current	I <sub>S</sub>	A		66		T <sub>C</sub> =25°C	Note1
Reverse recovery time	trr	nS		27		V <sub>R</sub> =800V, V <sub>GS</sub> =-4V, I <sub>D</sub> =40A, di/dt=2250A/uS	
Reverse recovery charge	Qrr	nC		478			
Peak reverse recovery current	Irrm	A		27			

Note 1: When using SiC Body Diode the maximum recommended V<sub>GS</sub> = -4V

Note 2: MOSFET can also safely operate at 0/15 V

## ■Thermal Characteristics (T<sub>a</sub>=25°C Unless otherwise specified)

PARAMETER	SYMBOL	UNIT	Typ.
Thermal resistance	R <sub>θJ-C</sub>	°C/W	0.45

## ■Typical Characteristics

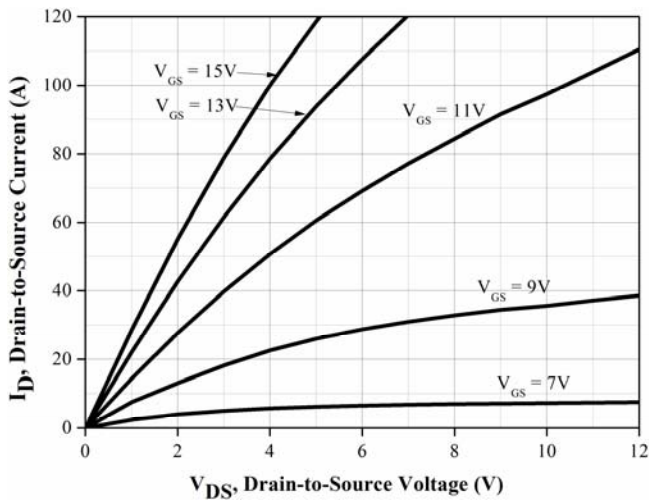

Figure 1. Output Characteristics T<sub>j</sub> = -55°C

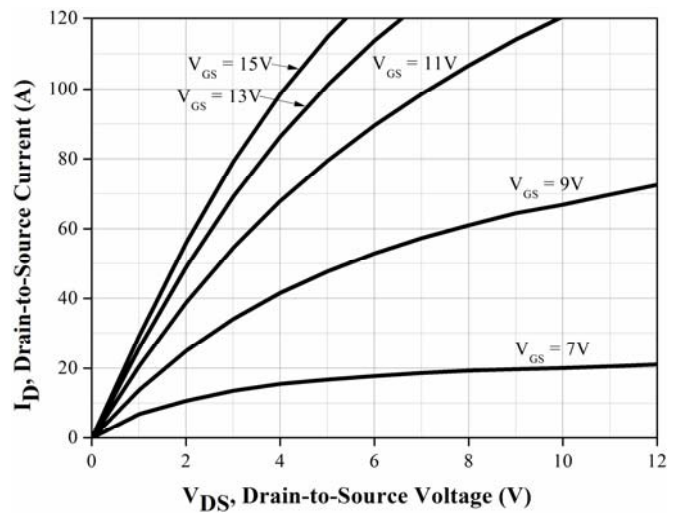

Figure 2. Output Characteristics T<sub>j</sub> = 25°C



# YJD212040NCTG2Q

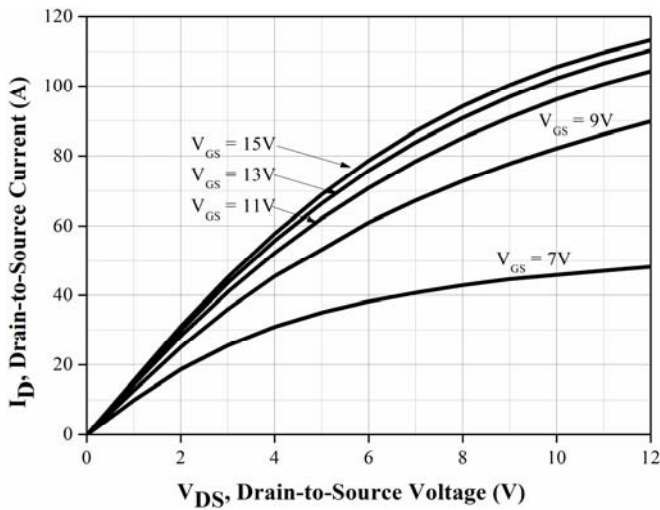

Figure 3. Output Characteristics  $T_j = 175^\circ\text{C}$

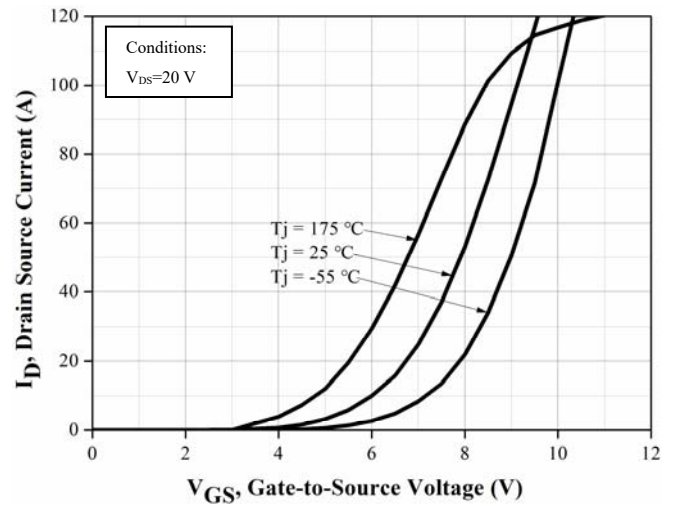

Figure 4. Transfer Characteristics for various junction temperature

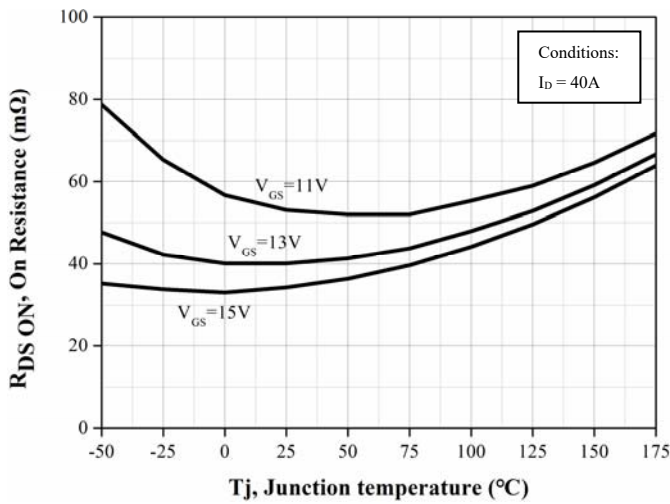

Figure 5. On-resistance vs. temperature for various gate voltage

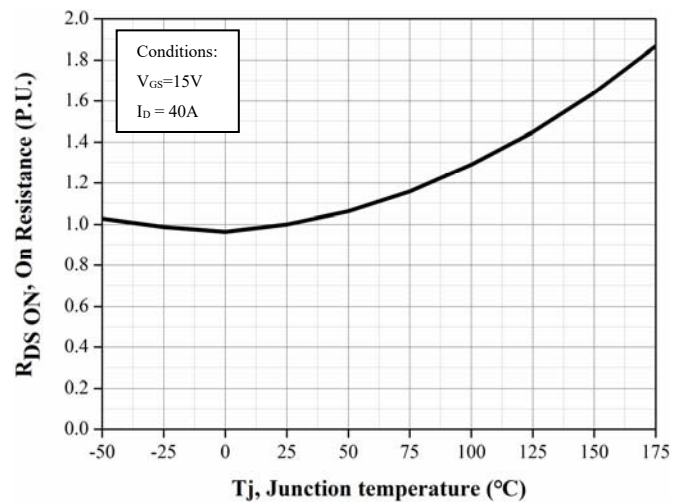

Figure 6. Normalized on-resistance vs. temperature

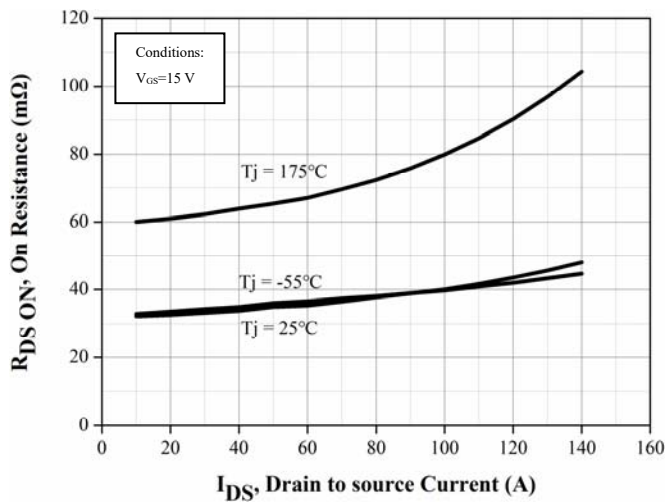

Figure 7. On-resistance vs. drain current

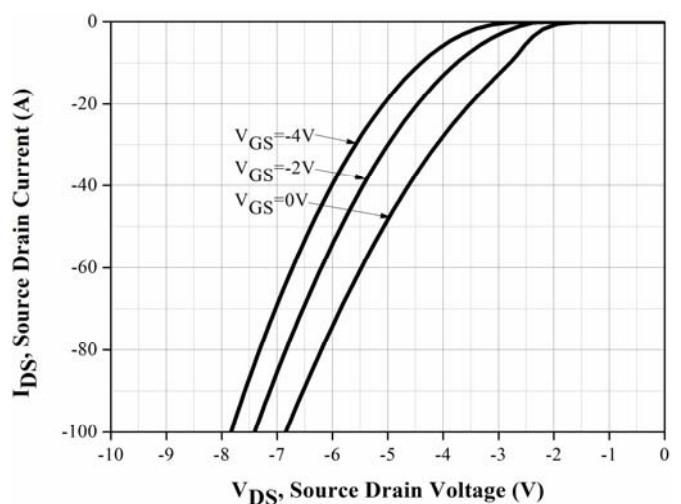

Figure 8. Body diode characteristic at  $T_j = 25^\circ\text{C}$



# YJD212040NCTG2Q

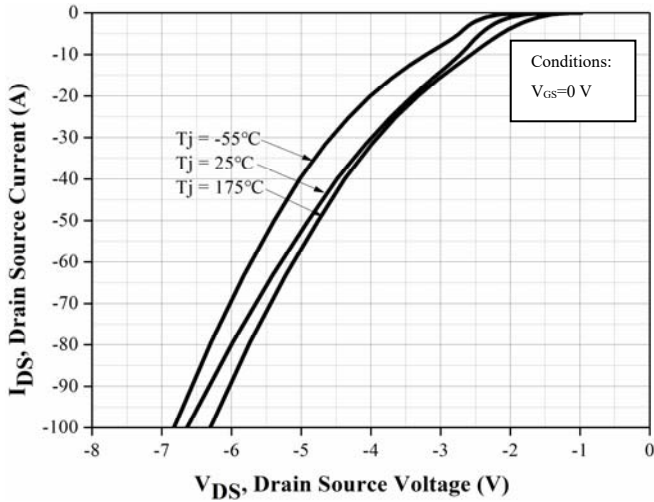

Figure 9. Body diode characteristic

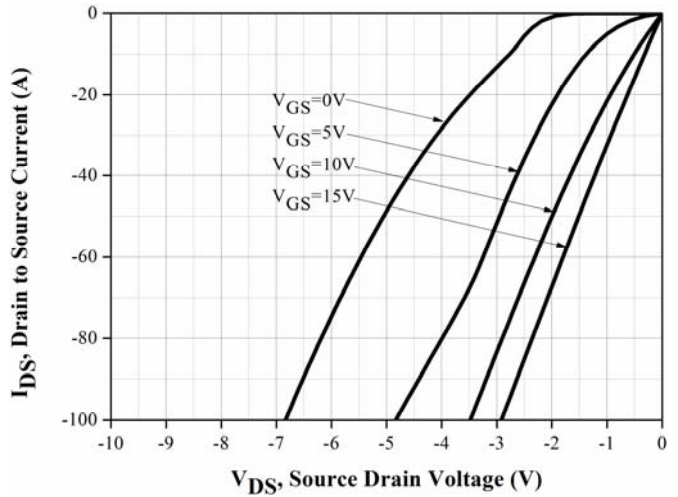

Figure 10. 3<sup>rd</sup> quadrant characteristic at  $T_j = 25^\circ\text{C}$

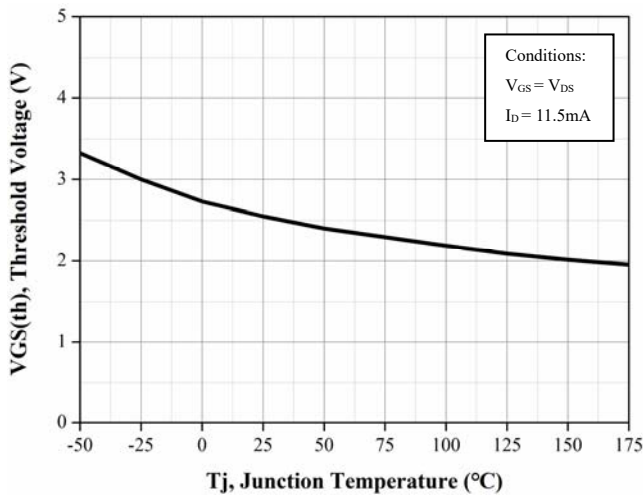

Figure 11. Threshold voltage vs. temperature

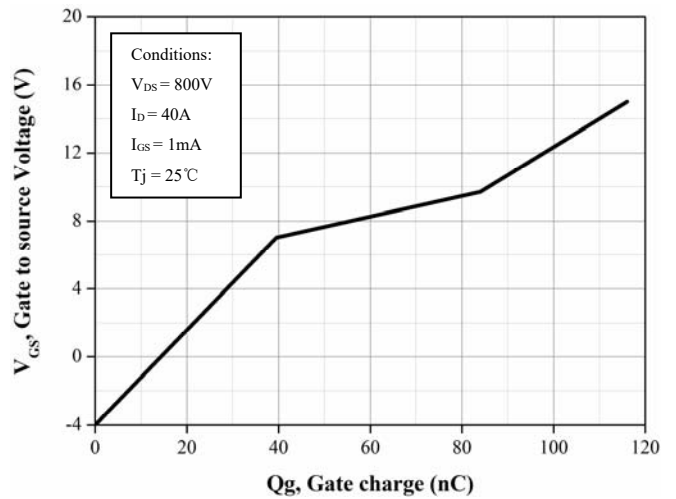

Figure 12. Gate charge characteristic

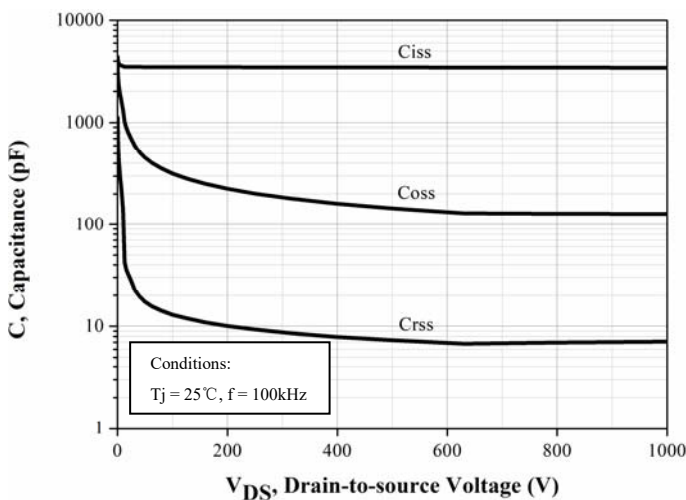

Figure 13. Capacitances vs. drain source voltage (0-1000V)

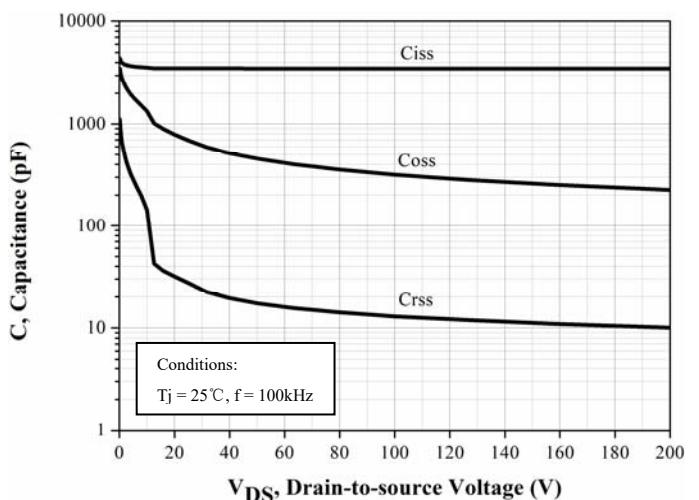

Figure 14. Capacitances vs. drain source voltage (0-200V)



# YJD212040NCTG2Q

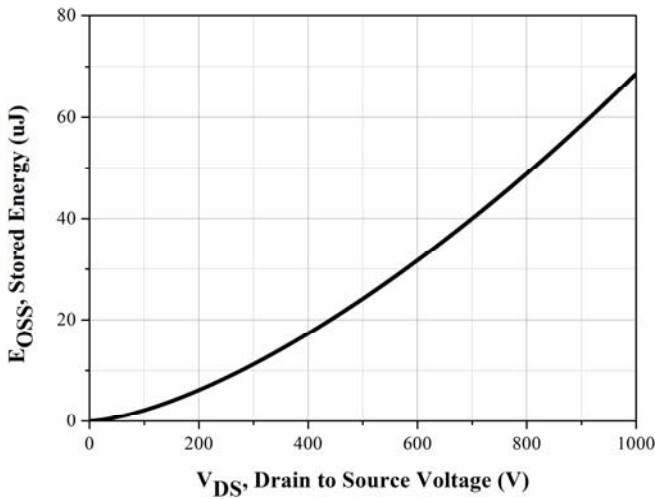

Figure 15. Output capacitor stored energy

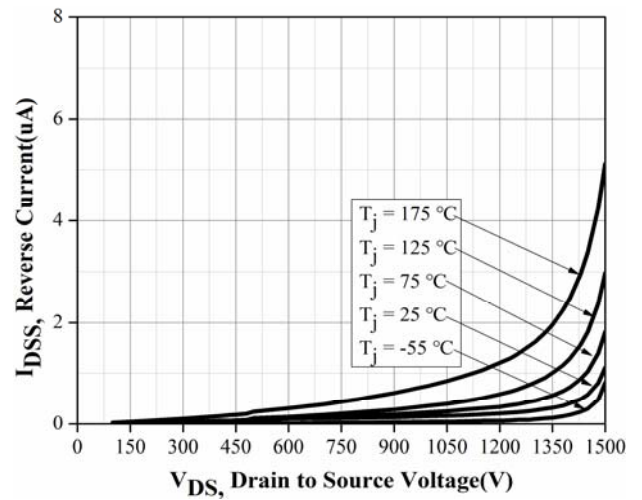

Figure 16. Reverse characteristics vs. Tj

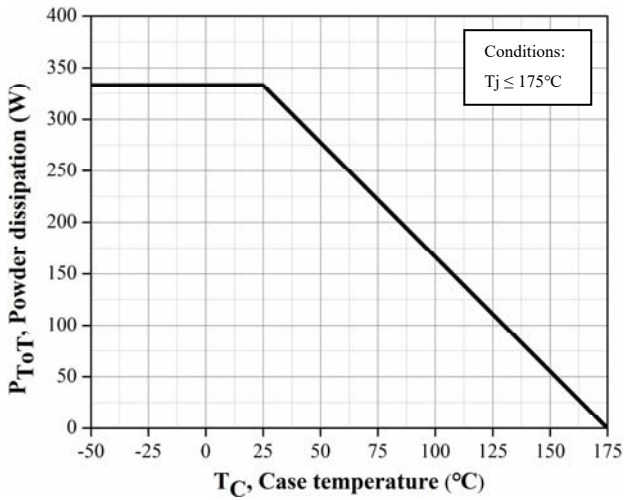

Figure 17. Maximum power dissipation derating vs. case temperature

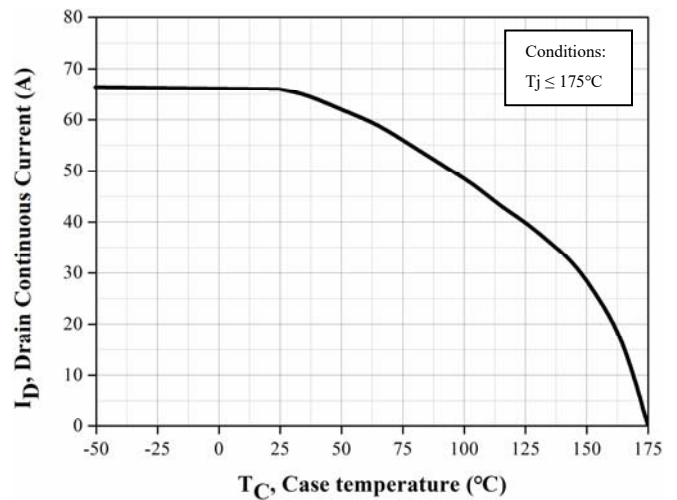

Figure 18. Continuous drain current derating vs. case temperature

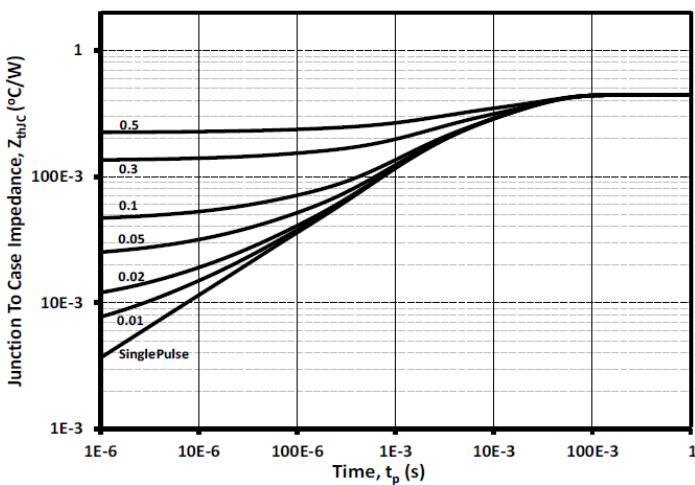

Figure 19. Transient thermal impedance (junction - case)

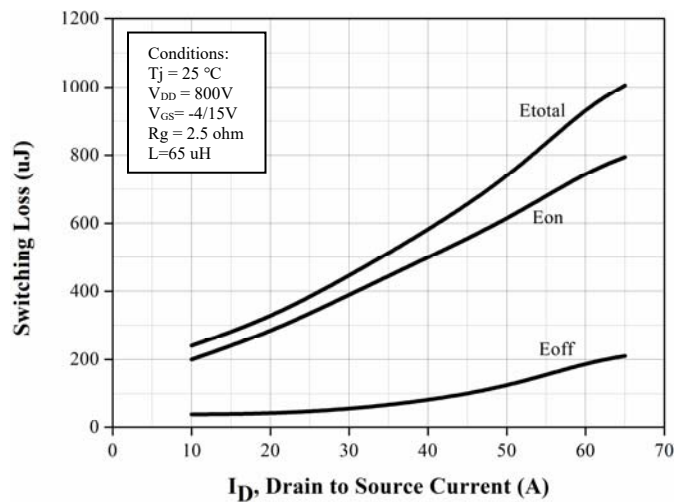

Figure 20. Clamped Inductive switching energy vs. drain current

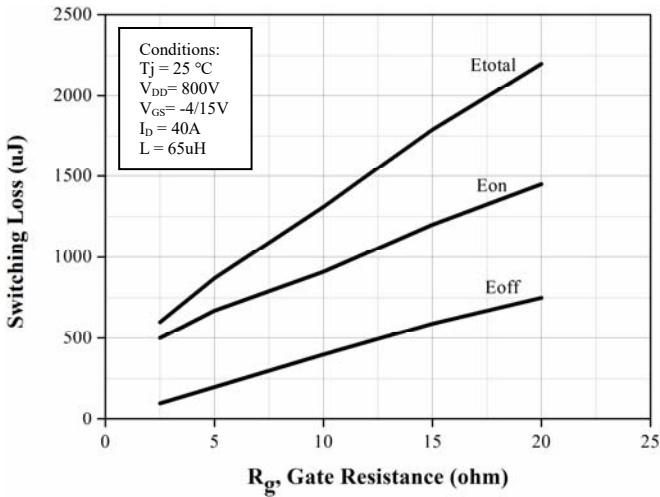

Figure 21. Clamped inductive switching energy vs. Rg

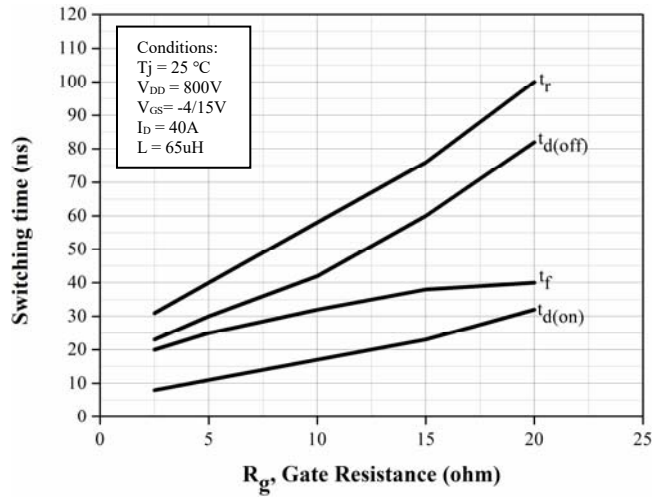

Figure 22. Switching times vs. Rg

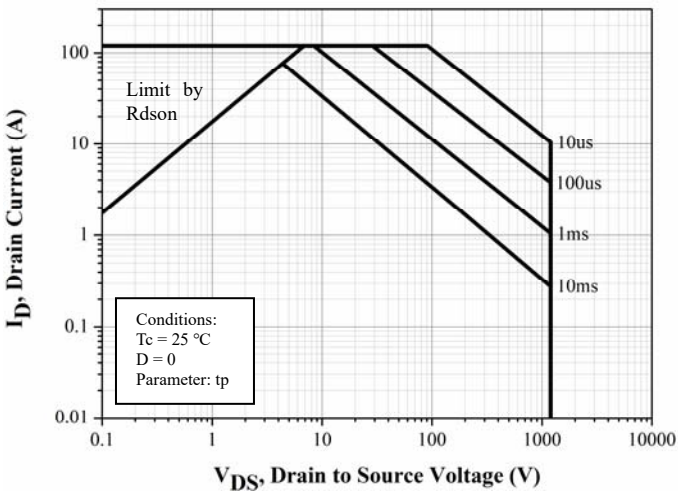

Figure 23. Safe Operating Area

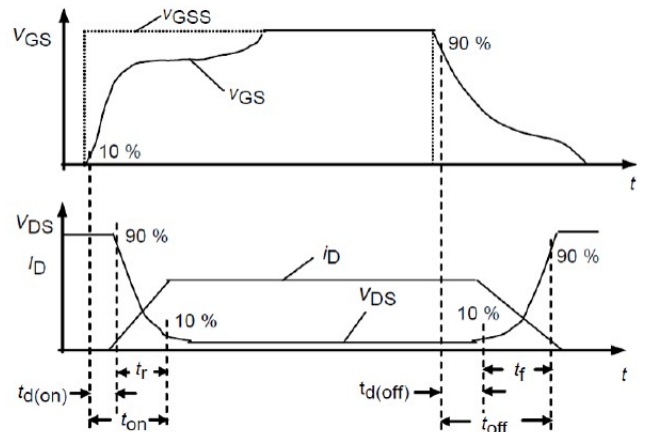

Figure 24. Switching Times Definition

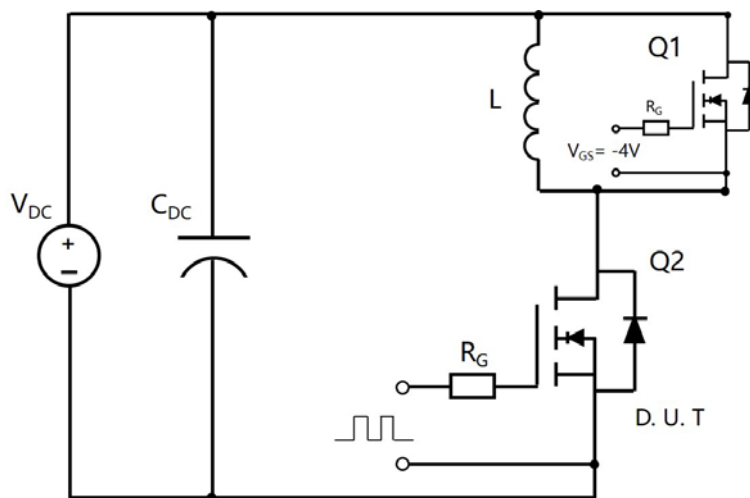
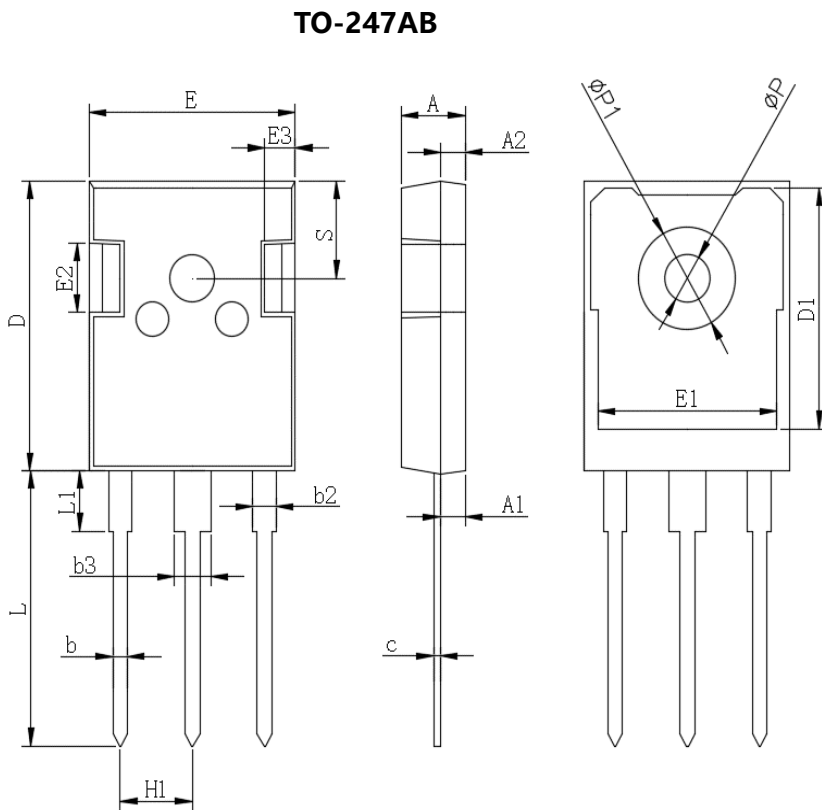

Figure 25. Clamped Inductive Switching Waveform Test Circuit

## ■Outline Dimensions



TO-247AB		
Dim	Min	Max
A	4.80	5.20
A1	2.21	2.61
A2	1.85	2.15
b	1.0	1.4
b2	1.91	2.21
C	0.5	0.7
D	20.70	21.30
D1	16.25	16.85
E	15.50	16.10
E1	13.0	13.6
E2	4.80	5.20
E3	2.30	2.70
L	19.62	20.22
L1	-	4.30
$\phi P$	3.40	3.80
$\phi P1$	-	7.30
S	6.15TYP	
H1	5.44TYP	
b3	2.80	3.20





## YJD212040NCTG2Q

---

### Disclaimer

The information presented in this document is for reference only. Yangzhou Yangjie Electronic Technology Co., Ltd. reserves the right to make changes without notice for the specification of the products displayed herein to improve reliability, function or design or otherwise.

The product listed herein is designed to be used with ordinary electronic equipment or devices, and not designed to be used with equipment or devices which require high level of reliability and the malfunction of which would directly endanger human life (such as medical instruments, transportation equipment, aerospace machinery, nuclear-reactor controllers, fuel controllers and other safety devices), Yangjie or anyone on its behalf, assumes no responsibility or liability for any damages resulting from such improper use of sale.

This publication supersedes & replaces all information previously supplied. For additional information, please visit our website [http:// www.21yangjie.com](http://www.21yangjie.com) , or consult your nearest Yangjie's sales office for further assistance.