

N-Channel Enhancement Mode Field Effect Transistor

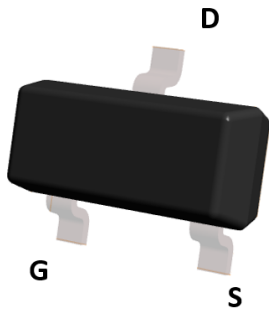

Top View

SOT-23

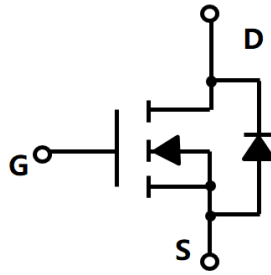
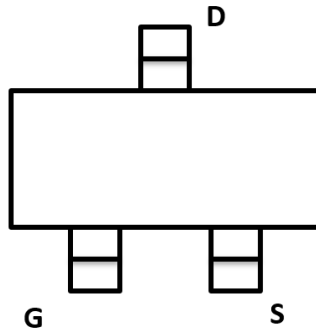

Product Summary

- V_{DS} 60V
- I_D 3.0A
- $R_{DS(ON)}$ (at $V_{GS}= 10V$) <100mohm
- $R_{DS(ON)}$ (at $V_{GS}= 4.5V$) <120mohm
- $R_{DS(ON)}$ (at $V_{GS}= 2.5V$) <200mohm

General Description

- Trench Power LV MOSFET technology
- High Density Cell Design for Low $R_{DS(ON)}$
- High Speed switching

Applications

- Battery protection
- Load switch
- Power management

■ Absolute Maximum Ratings ($T_A=25^\circ\text{C}$ unless otherwise noted)

Parameter		Symbol	Limit	Unit
Drain-source Voltage		V_{DS}	60	V
Gate-source Voltage		V_{GS}	± 16	V
Drain Current	$T_A=25^\circ\text{C}$	I_D	3	A
	$T_A=70^\circ\text{C}$		2.4	
Pulsed Drain Current ^A		I_{DM}	12	A
Total Power Dissipation @ $T_A=25^\circ\text{C}$ Steady State		P_D	1.2	W
Thermal Resistance Junction-to-Ambient ^B		$R_{\theta JA}$	105	$^\circ\text{C}/\text{W}$
Junction and Storage Temperature Range		T_J, T_{STG}	-55~+150	$^\circ\text{C}$

■ Ordering Information (Example)

PREFERRED P/N	PACKING CODE	Marking	MINIMUM PACKAGE(pcs)	INNER BOX QUANTITY(pcs)	OUTER CARTON QUANTITY(pcs)	DELIVERY MODE
YJL03N06B	F2	S10B.	3000	30000	120000	7" reel



YJL03N06B

■ Electrical Characteristics (T_J=25°C unless otherwise noted)

Parameter	Symbol	Conditions	Min	Typ	Max	Units
Static Parameter						
Drain-Source Breakdown Voltage	BV _{DSS}	V _{GS} =0V, I _D =250μA	60			V
Zero Gate Voltage Drain Current	I _{DSS}	V _{DS} = 60V, V _{GS} =0V			1	μA
Gate-Body Leakage Current	I _{GSS}	V _{GS} =± 16V, V _{DS} =0V			± 100	nA
Gate Threshold Voltage	V _{GS(th)}	V _{DS} = V _{GS} , I _D = 250μA	0.65	0.95	1.55	V
Static Drain-Source On-Resistance	R _{DS(ON)}	V _{GS} = 10V, I _D = 3A		86	100	mΩ
		V _{GS} = 4.5V, I _D = 2A		90	120	
		V _{GS} = 2.5V, I _D = 1A		100	200	
Diode Forward Voltage	V _{SD}	I _S = 3.0A, V _{GS} =0V		0.8	1.2	V
Dynamic Parameters						
Input Capacitance	C _{iss}	V _{DS} =30V, V _{GS} =0V, f=1MHZ		451		pF
Output Capacitance	C _{oss}			38		
Reverse Transfer Capacitance	C _{rss}			31		
Switching Parameters						
Total Gate Charge	Q _g	V _{GS} = 10V, V _{DS} = 30V, I _D = 3.0A		13.8		nC
Gate-Source Charge	Q _{gs}			2.2		
Gate-Drain Charge	Q _{gd}			1.9		
Reverse Recovery Charge	Q _{rr}	I _F = 3A, di/dt=100A/us		7.6		ns
Reverse Recovery Time	t _{rr}			30		
Turn-on Delay Time	t _{D(on)}	V _{GS} = 10V, V _{DS} = 30V, I _D = 1.5A R _{GEN} = 3Ω		3		ns
Turn-on Rise Time	t _r			18		
Turn-off Delay Time	t _{D(off)}			17		
Turn-off fall Time	t _f			22		

A. Pulse Test: Pulse Width ≤ 300us, Duty cycle ≤ 2%.

B. R_{θJA} is the sum of the junction-to-lead and lead-to-ambient thermal resistance, where the lead thermal reference is defined as the solder mounting surface of the drain pins. R_{θJL} is guaranteed by design, while R_{θJA} is determined by the board design. The maximum rating presented here is based on mounting on a 1 in 2 pad of 2oz copper.



■ Typical Performance Characteristics

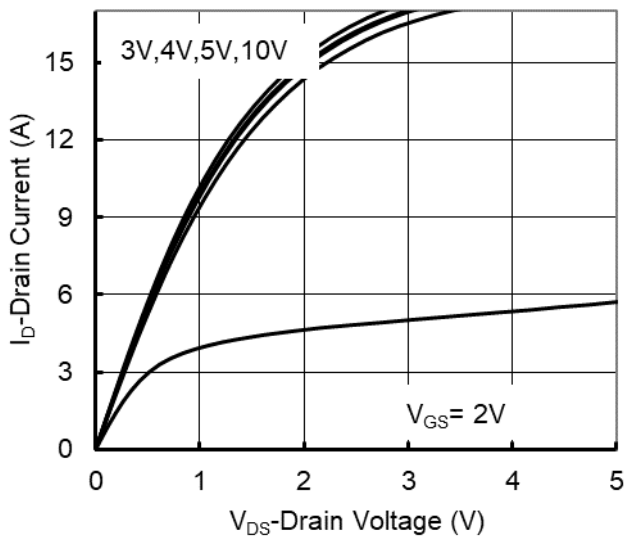

Figure1. Output Characteristics

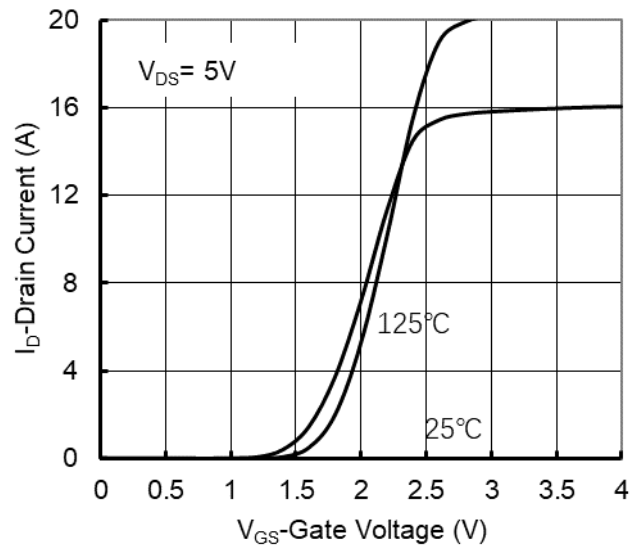

Figure2. Transfer Characteristics

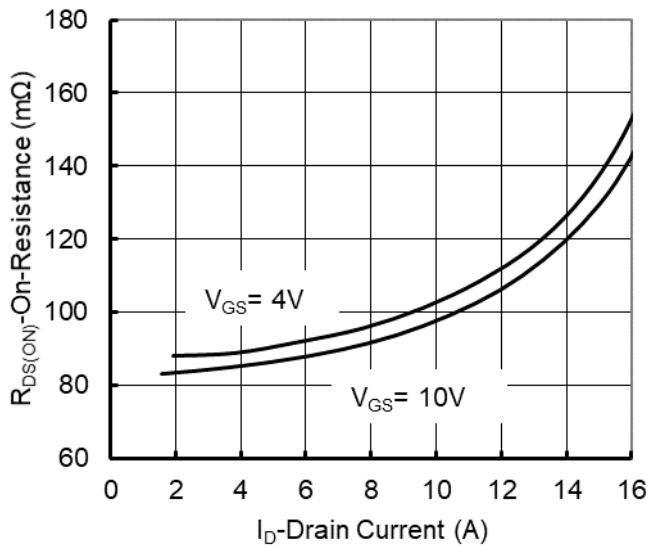

Figure 3: On-Resistance vs. Drain Current and Gate Voltage

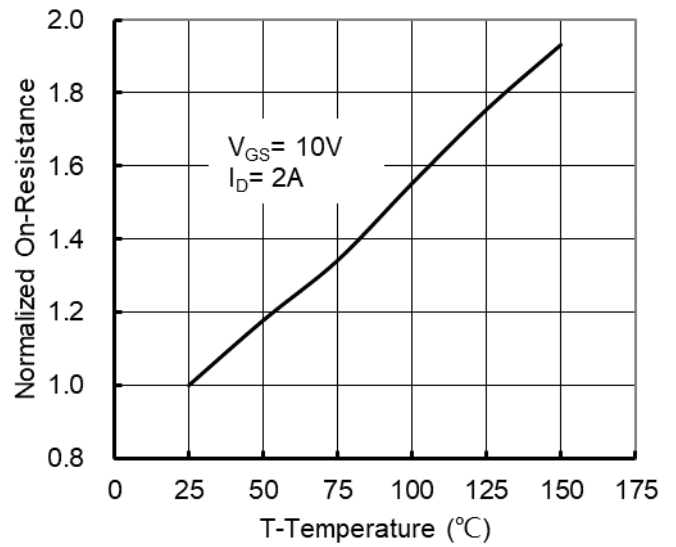

Figure 4: On-Resistance vs. Junction Temperature

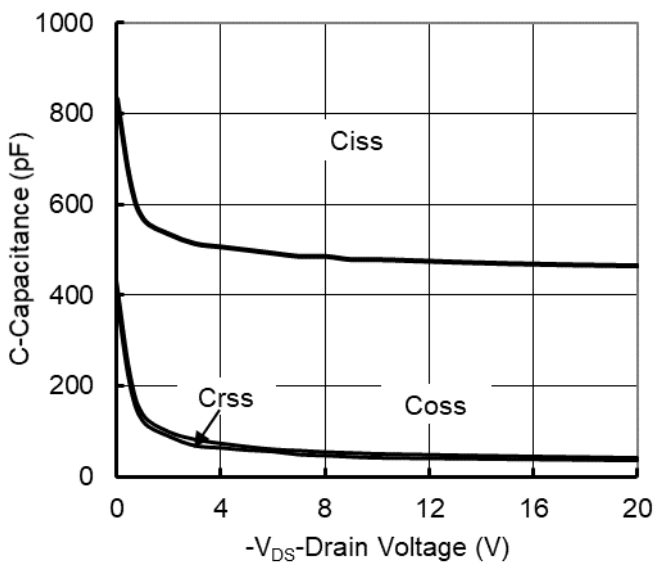

Figure5. Capacitance Characteristics

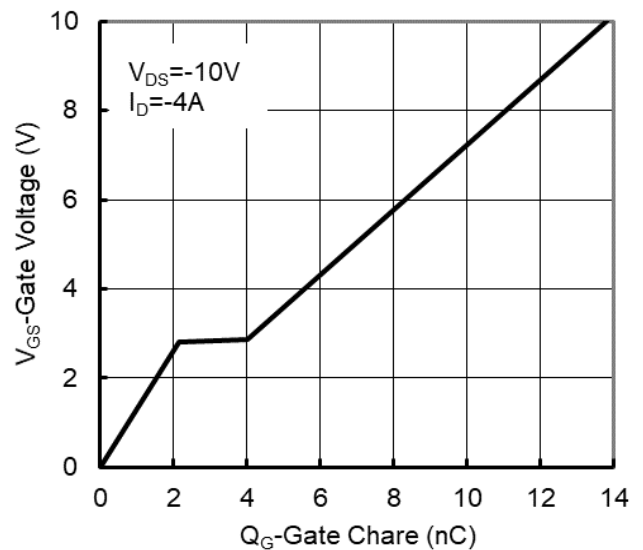

Figure6. Gate Charge



YJL03N06B

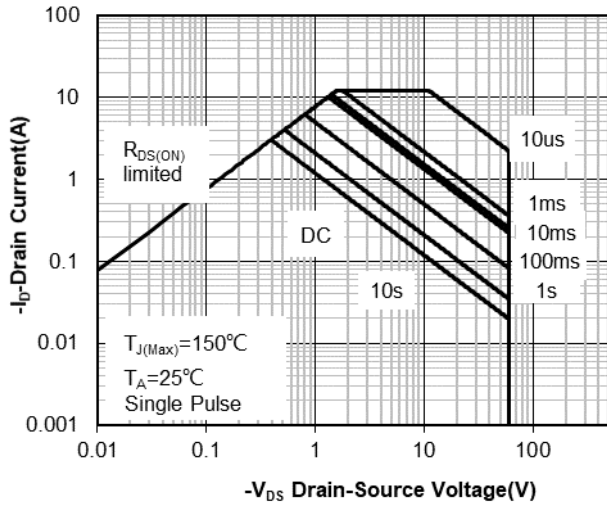

Figure7. Safe Operation Area

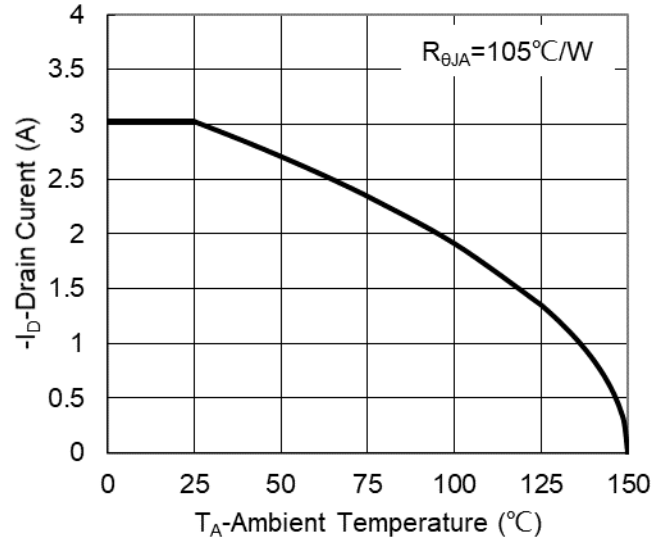

Figure8. Maximum Continuous Drain Current vs Ambient Temperature

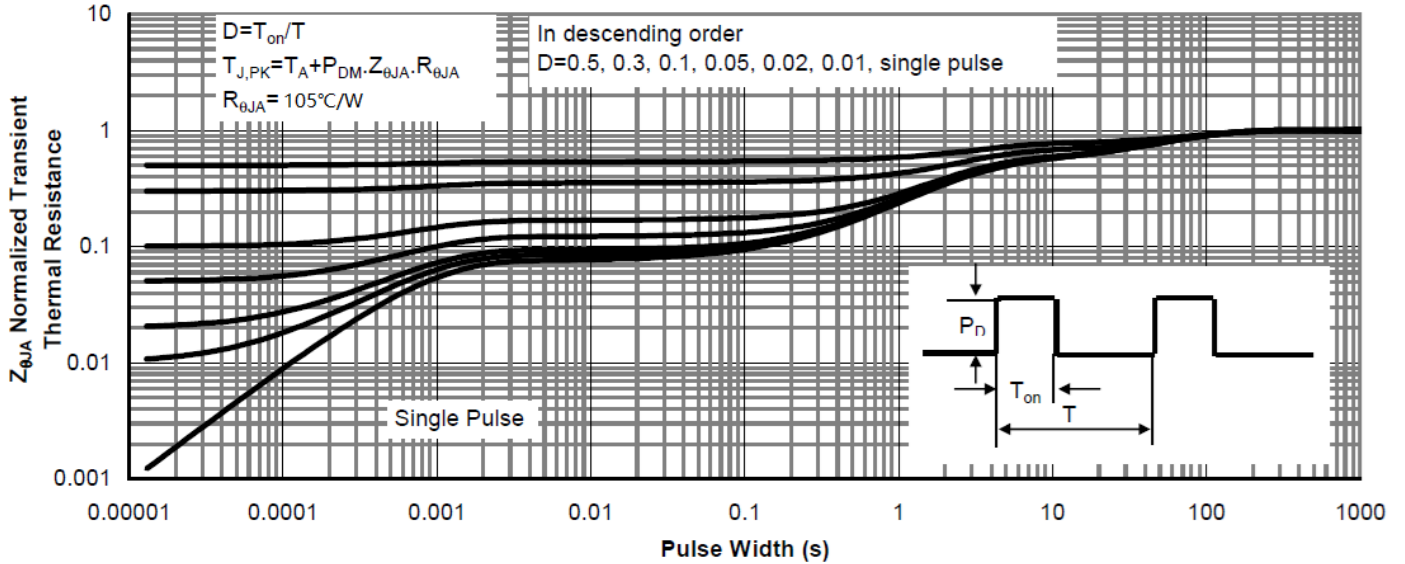
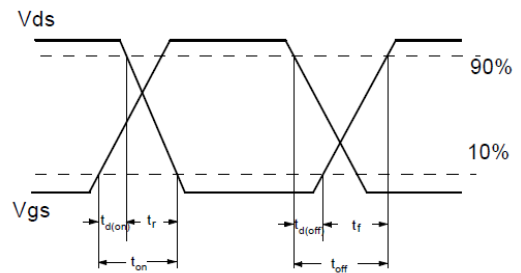
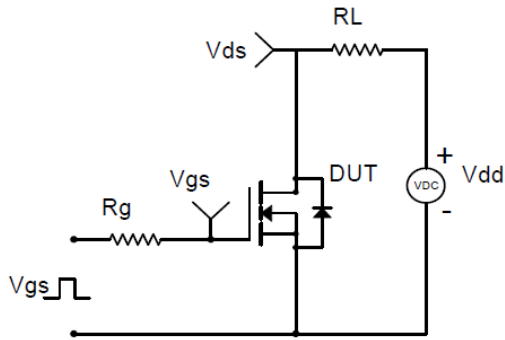
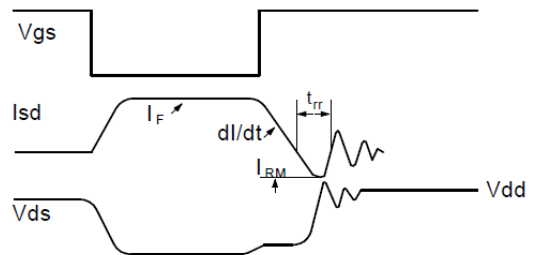
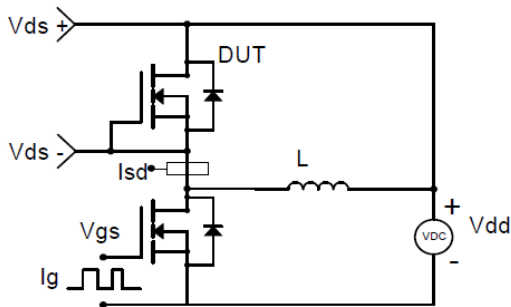

Figure9. Normalized Maximum Transient Thermal Impedance



Resistive Switching Test Circuit & Waveforms



Diode Recovery Test Circuit & Waveforms

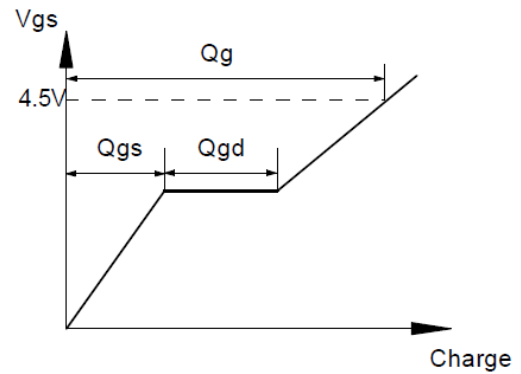
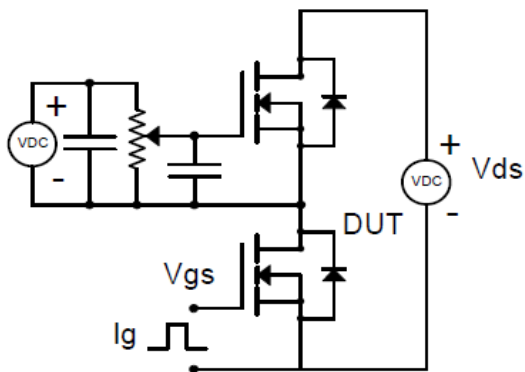

Gate Charge Test Circuit & Waveform

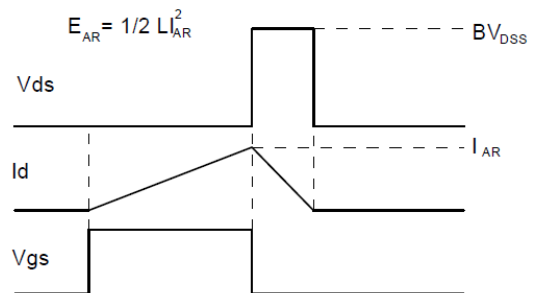
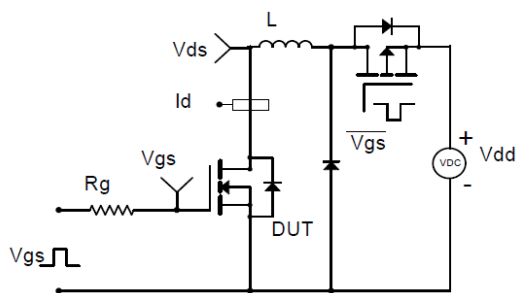

Unclamped Inductive Switching (UIS) Test Circuit & Waveforms



YJL03N06B

■ SOT-23 Package Information

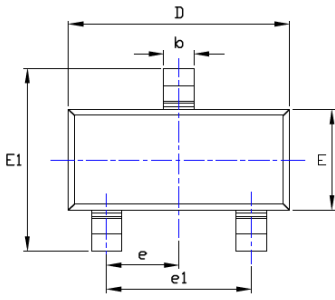

TOP VIEW

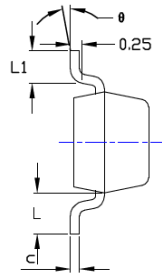

SIDE VIEW

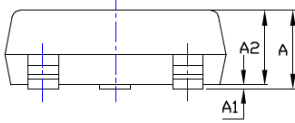

SIDE VIEW

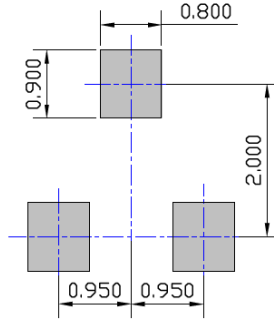

UNIT: mm

SUGGESTED SOLDER PAD LAYOUT

SYMBOL	DIMENSIONS			
	INCHES		Millimeter	
	MIN.	MAX.	MIN.	MAX.
A	0.035	0.045	0.900	1.150
A1	0.000	0.004	0.000	0.100
A2	0.035	0.041	0.900	1.050
b	0.012	0.020	0.300	0.500
c	0.004	0.008	0.100	0.200
D	0.110	0.118	2.800	3.000
E	0.047	0.055	1.200	1.400
E1	0.089	0.100	2.250	2.550
e	0.037TYP		0.950TYP	
e1	0.071	0.079	1.800	2.000
L	0.022REF		0.550REF	
L1	0.012	0.200	0.300	0.500
θ	0°	8°	0°	8°

- NOTE:**
 1. PACKAGE BODY SIZES EXCLUDE MOLD FLASH AND GATE BURRS.
 2. TOLERANCE 0.1mm UNLESS OTHERWISE SPECIFIED.
 3. THE PAD LAYOUT IS FOR REFERENCE PURPOSES ONLY.



YJL03N06B

Disclaimer

The information presented in this document is for reference only. Yangzhou Yangjie Electronic Technology Co., Ltd. reserves the right to make changes without notice for the specification of the products displayed herein to improve reliability, function or design or otherwise.

The product listed herein is designed to be used with ordinary electronic equipment or devices, and not designed to be used with equipment or devices which require high level of reliability and the malfunction of which would directly endanger human life (such as medical instruments, transportation equipment, aerospace machinery, nuclear-reactor controllers, fuel controllers and other safety devices), Yangjie or anyone on its behalf, assumes no responsibility or liability for any damages resulting from such improper use of sale.

This publication supersedes & replaces all information previously supplied. For additional information, please visit our website [http:// www.21yangjie.com](http://www.21yangjie.com) , or consult your nearest Yangjie's sales office for further assistance.